

Assmby Instruction

Base Blind Corner

Code	Description	Qty.
A	Side Panel (L/R)	2
B	Face Frame	1
C	Back Panel	1
D	Bottom Panel	1
E	Shelf	1
F	Toe Kick	1
G	Drawer Box (Side/bottom panels)	5 (1set)
H	Drawer Face	1
I	Door	1
J	Plastic Shelf Clips	4
K	Sliders & Adapter	2 pairs
L	Plastic Slider holder	2
M	Hinges	2
N	Support Bracket (wooden)	4

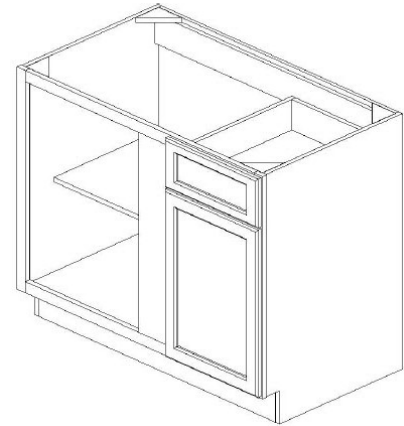

For Product lines:
 Modern Gray/Frenso Gray Shaker/Anaheim
 Gray/Beech Espresso

Required Tools:

Power Drill



Rubber Hammer



**EASY ASSEMBLY
 METAL CLIP SYSTEM**



- Align Clips ① and ②
- Slide ① into ②
- Insert locking screw into clip pair
- Tighten all screws

Step-by-Step Instruction:

Step 1	Step 2
<p>Lay back panel (C) flat, grooves facing upward</p> <p>Insert Side panel (A) on (C) and secure with metal clips (Refer to Metal clip system above)</p>	<p>Slide bottom panel (D) into grooves of (A) and (C)</p>

Assmly Instruction

Base Blind Corner

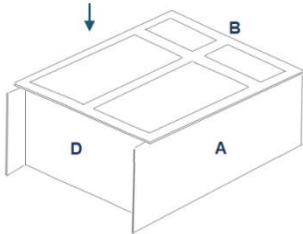
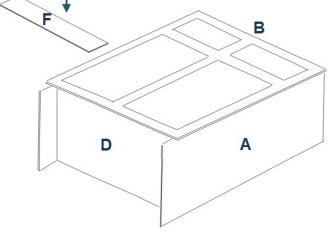
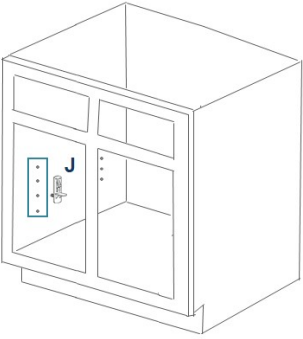
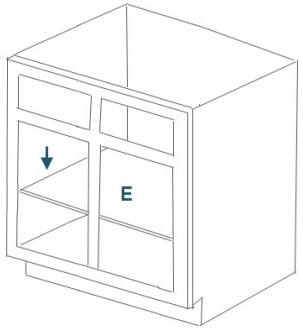
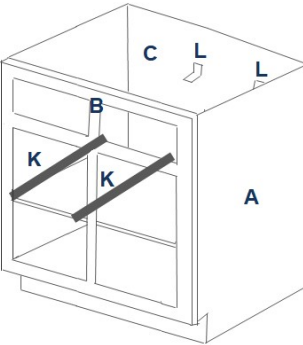
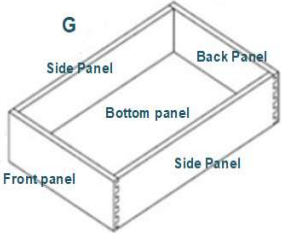

<p>Step 3</p> <p>Attach Front frame (B) onto (A) (Referal to metal clip system above)</p>		<p>Step 4</p> <p>Attach Toe kick (F) onto bottom front of (A) (Referal to metal clip system above)</p>	
<p>Step 5</p> <p>Insert Plastic shelf clips (J) onto pre-drilled holds on A</p>		<p>Step 6</p> <p>Slide in shelf (E) and make sure the finished front edge facing out</p>	
<p>Step 7</p> <p>Screw both rear slider holder brackets (L) into pre-drill holes in C, angle facing upward</p> <p>Install sliders (K) into L and screw into the side of B</p> <p><i>*Slider Holder (L) can be installed on the left or right, depends on the blind side, install accordingly*</i></p>		<p>Step 8</p> <p>Assemble the drawer box by using Rubber Hammer</p> <p><i>*Use wood glue for a permanent bond*</i></p> <p>(Beech espresso drawer box using screw assembly)</p>	

Assmly Instruction

Base Blind Corner

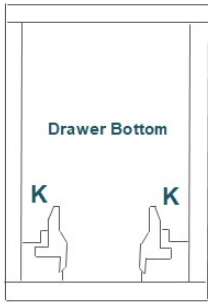
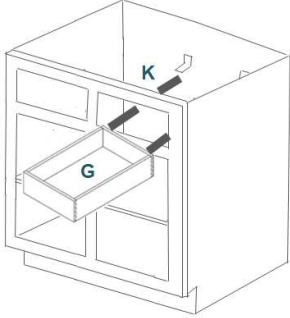
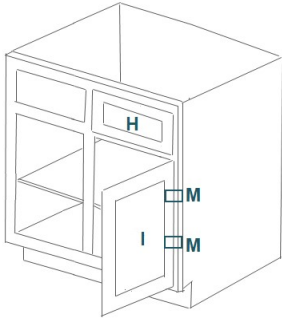
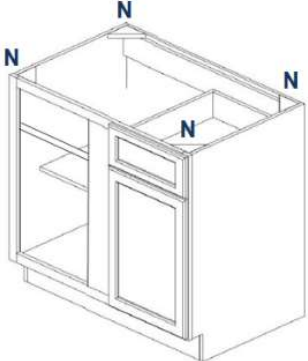

Step 9		Step 10			
<p>Attach plastic adapter underneath the drawer</p> <p>There will be a letter indicating L or R side</p>	 <p>Drawer Bottom</p> <p>K K</p>	<p>Position Drawer box G over drawer sliders K</p>			
Step 11	Step 12	<p>Attach Drawer face (H) onto drawer front</p> <p>Attach Hinge (M) on the face frame, and then install door (I) onto hinge</p>	 <p>H</p> <p>M M</p> <p>I</p>	<p>Place Wooden support brackets (N) into corners of A, B, C</p>	 <p>N N N N</p>